



INSTALLATION INSTRUCTIONS

21-861C (Gun Metal Gray Finish)
MAZDA
2018-20 6 / CX-9
L4-2.5L Turbo

NOT LEGAL FOR SALE OR USE ON ANY POLLUTION CONTROLLED MOTOR VEHICLE IN CALIFORNIA OR STATES ADOPTING CALIFORNIA EMISSION PROCEDURES.

See aemintakes.com for CARB status on each part for a specific vehicle

TOOLS NEEDED:

3mm allen
 4mm allen
 flat blade screw driver
 Philips screw driver
 10mm wrench
 ratchet
 10mm socket
 pliers

PARTS LIST:

Description	Qty.	Part #
A HOSE CLAMP; #44	1	08577
B HOSE; HUMP 2.5"/3" X 3"	1	5-574
C HOSE CLAMP; #48	1	08601
D TUBE; 3"OD X 11"L, 21-861	1	2-1633C
E BOLT; M4-.7 X 8MM, ALLEN, SS	2	07733
F HEAT SHIELD; 2018 MAZDA 6	1	20-8647
G BOLT; M6 X 1.00" 12MM, SS	4	07794
H WASHER; M6 SPLIT LOCK ZINC	4	1-3025
I WASHER; 6MM FLAT, SS	8	08269
J GROMMET; 1"OD, 1/2"ID, 1/2"	3	08064
K LID; HEAT SHIELD, MAZDA 6	1	20-8648
L NUT; 6MM NYLOCK, HEXHEAD	2	07512
M SPACER; ALUM, AEM-8-211	1	7-364
N PLATE; AEM LOGO, CLEAR	1	8-211
O BOLT; M6 X 1.00 X 16MM, SS	2	07730
P EDGE TRIM; 3/4" BULB, TOP	1	102472
Q 1/2" BNDHOSE CLAMP, 3.15"	1	9456
R AIR FILTER; 3.25" X 5"	1	21-2110DK

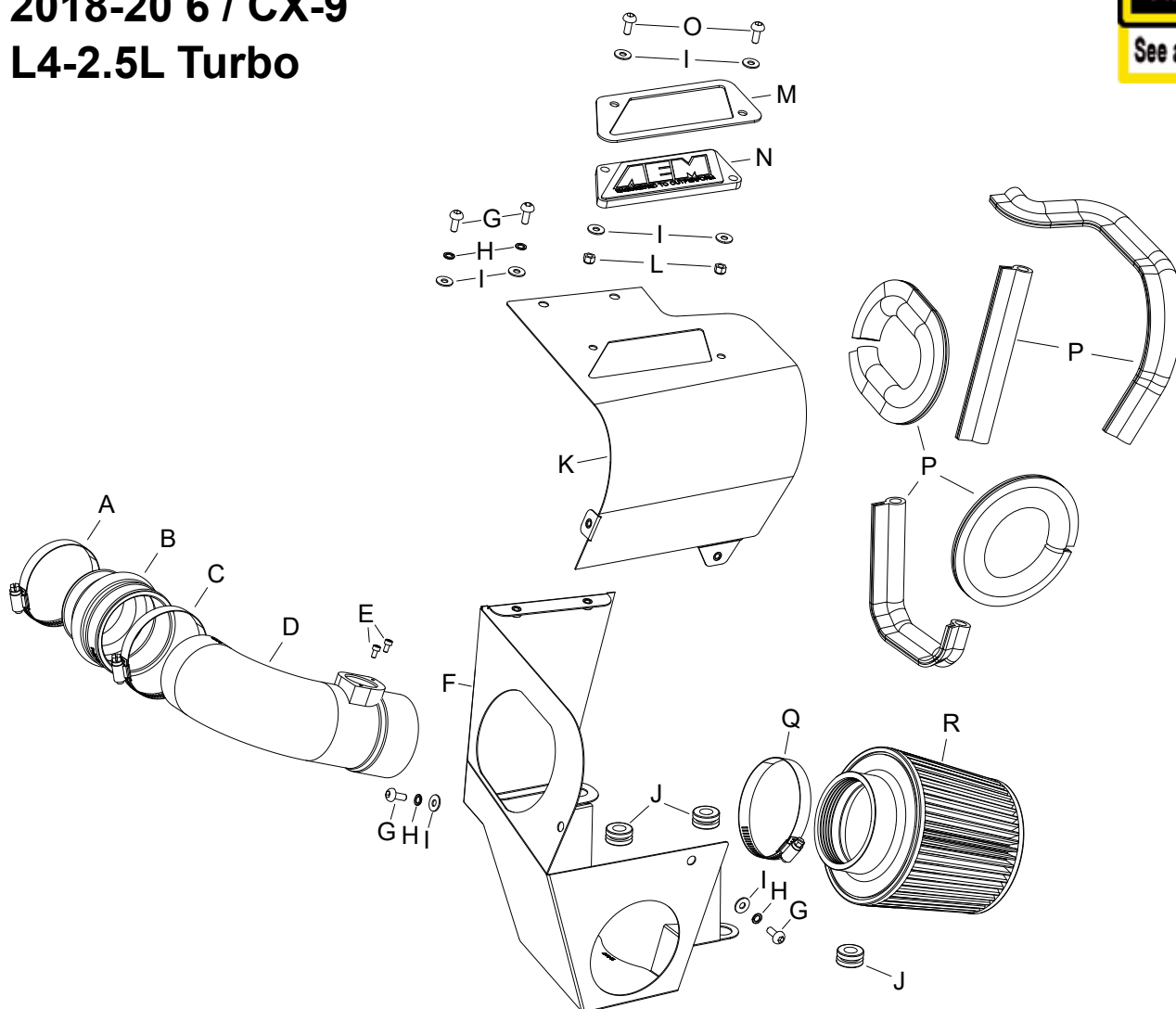

If you need any assistance please call 1-800-858-3333 to speak with a representative in our Customer Service Center before returning the product.

Read and understand these instructions **BEFORE** attempting to install this product. Failure to follow installation instructions and not using the provided hardware may damage the intake tube, throttle body and engine.

TO START:

1. Turn off the ignition and disconnect the negative battery cable.

NOTE: Disconnecting the negative battery cable erases pre-programmed electronic memories. Write down all memory settings before disconnecting the negative battery cable. Some radios will require an anti-theft code to be entered after the battery is reconnected. The anti-theft code is typically supplied with your owner's manual. In the event your vehicles anti-theft code cannot be recovered, contact an authorized dealership to obtain your vehicles anti-theft code.



2. Disconnect the mass air sensor electrical connection.



3. Loosen the clamps that secure the factory intake hose and then remove the factory hose from the vehicle.



4. Remove the two bolts that secure the fresh air intake scoop to the core support.



5. Pull straight up on the air filter housing assembly and remove it from the vehicle.

NOTE: AEM recommends that customers do not discard factory air intake.



6. Lift the locking tab and then rotate the fresh air scoop counter clockwise to remove it from the air filter housing.

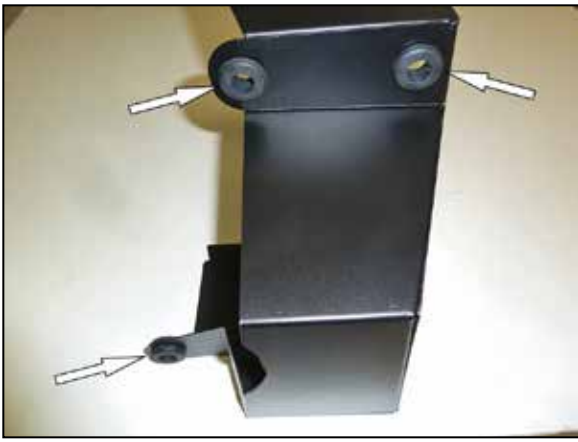

7. Install the three provided grommets into the heat shield as shown.



8. Cut the provided edge trim into the five lengths as shown.



9. Install the AEM® window into the heat shield lid and secure with the provided hardware.



10. Install the heat shield lid onto the heat shield and secure with the provided hardware.



11. Install the cut edge trim onto the heat shield as shown.



12. Install the factory fresh air intake scoop into the AEM® heat shield as shown.



13. Remove the mass air sensor from the factory air filter housing and install it into the AEM® intake tube and secure with the provided hardware.



14. Install the AEM® air filter onto the AEM® intake tube and secure with the provided hose clamp.



15. Install the intake tube assembly through the hole in the heat shield as shown.



16. Install the hump coupler (5-574) onto the turbo inlet pipe and secure with the provided hose clamp.



17. Install the AEM® intake assembly into the vehicle so the mounting grommets secure over the factory mounting studs.



18. Reconnect the mass air sensor electrical connection.



19. Install the intake tube into the coupler hose, adjust the tube for best fit and then secure the hose clamp.



20. Install the factory fresh air scoop bolts.



Reassemble Vehicle

Position the inlet pipes for the best fitment. Be sure that the pipes or any other components do not contact any part of the vehicle. Tighten the rubber mount, all bolts, and hose clamps. Check for proper hood clearance. Re-adjust pipes if necessary and re-tighten them. Inspect the engine bay for any loose tools and check that all fasteners that were moved or removed are properly tightened. Reconnect negative battery terminal and start engine. Let the vehicle idle for 3 minutes. Perform a final inspection before driving the vehicle.

Service and Maintenance

AEM Induction Systems requires cleaning the intake system's air filter element every 100,000 miles. When used in dusty or off-road environments, our filters will require cleaning more often. We recommend that you visually inspect your filter once every 25,000 miles to determine if the screen is still visible. When the screen is no longer visible some place on the filter element, it is time to clean it. To clean, purchase our Synthetic air filter cleaner, part number 99-0624 and follow the easy instructions. Use window cleaner to clean your powder coated AEM® intake tube.

NOTE: DO NOT USE aluminum polish on powder coated AEM® intake tubes.

NOT LEGAL FOR SALE OR USE ON ANY POLLUTION CONTROLLED MOTOR VEHICLE IN CALIFORNIA OR STATES ADOPTING CALIFORNIA EMISSION PROCEDURES.

See aemintakes.com for CARB status on each part for a specific vehicle

AEM Air Intake System Warranty Policy

AEM® warrants that its intake systems will last for the life of your vehicle. AEM will not honor this warranty due to mechanical damage (i.e. improper installation or fitment), damage from misuse, accidents or flying debris. AEM will not warrant its powder coating if the finish has been cleaned with a hydrocarbon-based solvent. The powder coating should only be cleaned with a mild soap and water solution. Proof of purchase of both the vehicle and AEM intake system is required for redemption of a warranty claim.

This warranty is limited to the repair or replacement of the AEM part. In no event shall this warranty exceed the original purchase price of the AEM part nor shall AEM be responsible for special, incidental or consequential damages or cost incurred due to the failure of this product. Warranty claims to AEM must be transportation prepaid and accompanied with dated proof of purchase. This warranty applies only to the original purchaser of product and is nontransferable. Improper use or installation, use for racing, accident, abuse, unauthorized repairs or alterations voids this warranty. AEM disclaims any liability for consequential damages due to breach of any written or implied warranty on all products manufactured by AEM. Warranty returns will only be accepted by AEM when accompanied by a valid Return Merchandise Authorization (RMA) number. Credit for defective products will be issued pending inspection. Product must be received by AEM within 30 days of the date RMA is issued.

If you have a warranty issue, please call (800) 992-3000 and our customer service department will assist you. A proof of purchase is required for all AEM warranty claims.