



INTAKE SYSTEMS FOR VEHICLES LISTED ARE 50 STATE LEGAL. SEE KNFILTERS.COM FOR CARB STATUS ON EACH PART FOR A SPECIFIC VEHICLE.

INSTALLATION INSTRUCTIONS

57-2563
MERCURY
2003-04 Marauder
V8-4.6L

TOOLS NEEDED:

- Flat Blade Screwdriver
- Ratchet
- Extension
- 8mm Socket
- 10mm Socket
- 11mm Socket
- 3mm Allen Wrench
- 5mm Allen Wrench

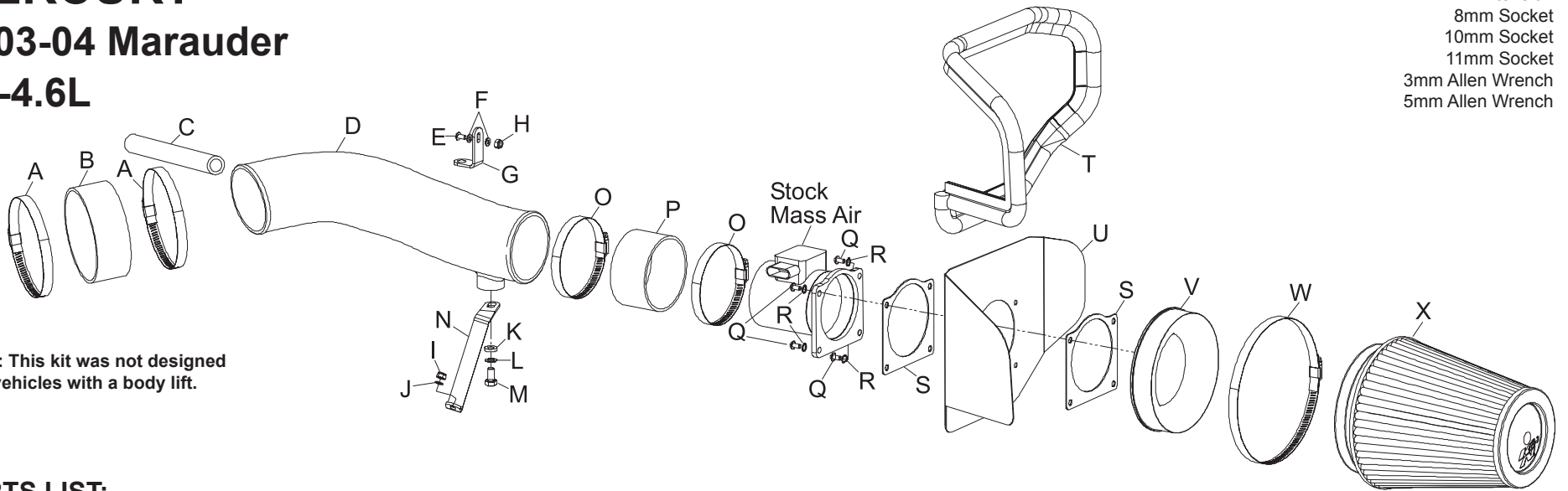

NOTE: This kit was not designed to fit vehicles with a body lift.

PARTS LIST:

Description	Qty.	Part #	Description	Qty.	Part #	Description	Qty.	Part #
A hose clamp #72	2	08671	I nut; 6mm hex, nylock	1	07553	Q bolt; m6-1.00 x 16mm, b/h/a	4	07730
B silicone hose	1	08623	J washer; 6mm flat	1	08275	R 1/4" split lock washer	4	08198
C silicone hose	1	084047	K washer; 5/16" flat	1	08276	S gasket; mass air	2	09984
D intake tube (EJ)	1	087137	L washer; 8mm wave	1	08239	T edge trim	1	102499
E bolt; m5-.8 x 8mm, b/h/a	1	07740	M bolt; 8mm-1.25 x 16mm hex	1	07844	U heat shield	1	07491
F washer; 5mm flat	2	08212	N bracket z	1	010086	V filter adapter #250	1	08785
G bracket "L"	1	070712	O hose clamp #56	2	08620	W hose clamp #104	1	08697
H nut; m5-.8, nylock	1	07507	P silicone hose	1	08630	X air filter	1	RF-1041

NOTE: FAILURE TO FOLLOW INSTALLATION INSTRUCTIONS AND NOT USING THE PROVIDED HARDWARE MAY DAMAGE THE INTAKE TUBE, THROTTLE BODY AND ENGINE.

TO START:

1. Turn off the ignition and disconnect the negative battery cable.

NOTE: Disconnecting the negative battery cable erases pre-programmed electronic memories. Write down all memory settings before disconnecting the negative battery cable. Some radios will require an anti-theft code to be entered after the battery is reconnected. The anti-theft code is typically supplied with your owner's manual. In the event your vehicles' anti-theft code cannot be recovered, contact an authorized dealership to obtain your vehicles anti-theft code.



2. Disconnect the mass air sensor electrical connection.



3. Disconnect the crank case vent hose from the valve cover vent fitting as shown.



4. Loosen the two hose clamps which secure the stock intake tube to the throttle body and mass air sensor and then remove the intake tube from the vehicle as shown.

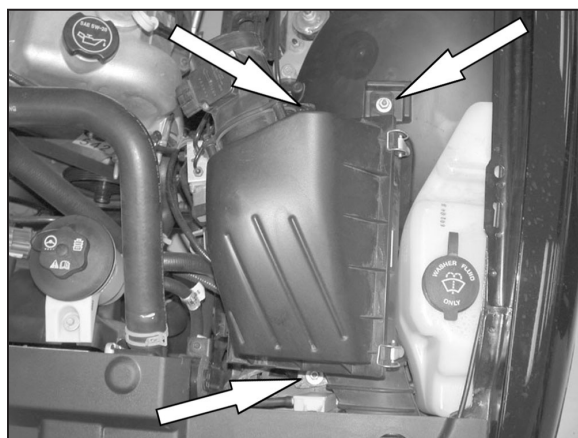

5. Loosen and remove the three air box mounting nuts shown.



6. Lift and remove the air box from the vehicle as shown.

NOTE: K&N Engineering, Inc., recommends that customers do not discard factory air intake.



7. Remove the air compressor muffler-retaining pin shown and then remove the muffler from the core support.

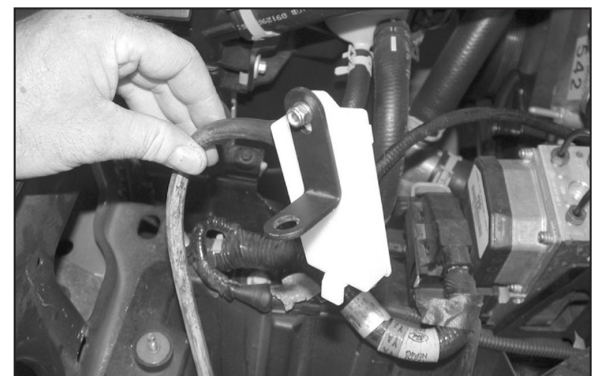

8. Using the provided hardware, secure the muffler to the "L" bracket (070712) as shown.

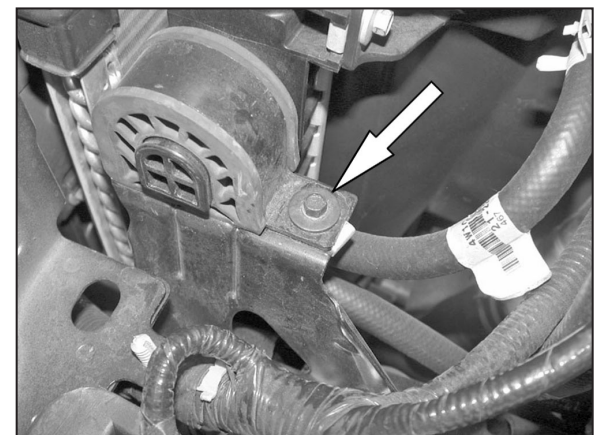

9. Remove the radiator mounting bolt shown.



10. Secure the muffer assembly with the bolt removed in step #9 to the radiator mount.

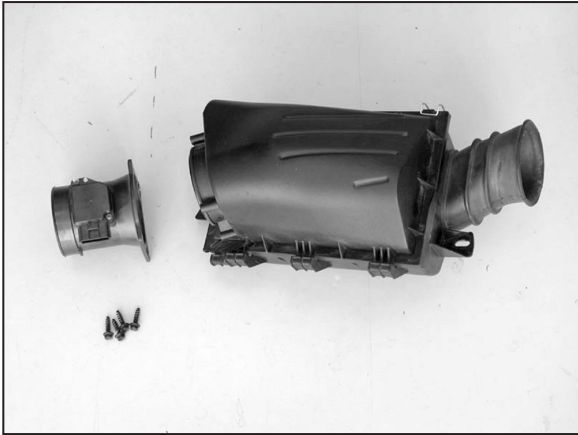

11. Remove the mass air sensor from the air box as shown.

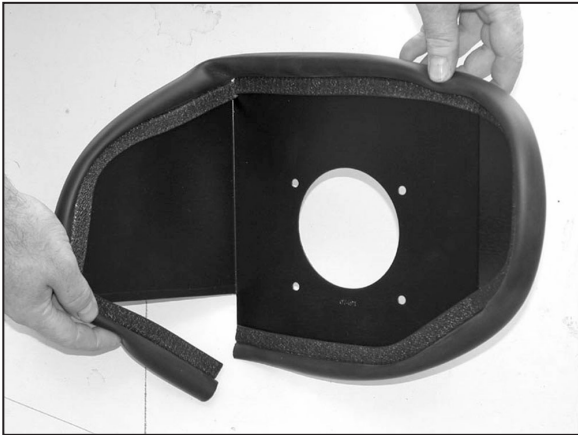

12. Install the provided edge trim onto the heat shield as shown.

NOTE: Some trimming of the edge trim may be necessary.



13. Install the radius filter adapter, gaskets and heat shield assembly onto the mass air sensor with the provided hardware as shown.



14. Install the silicone hose (08630) onto the mass air sensor and secure with the provided hose clamp as shown.

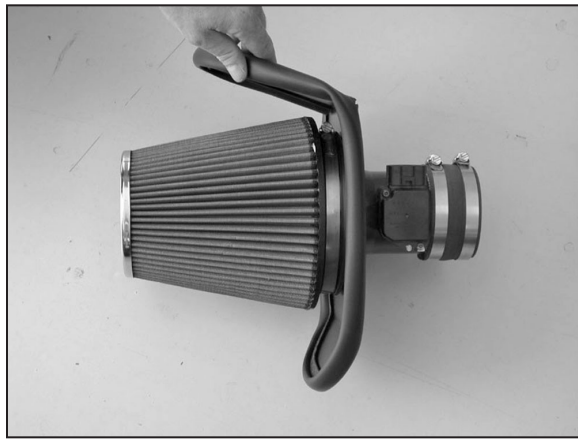

15. Install the K&N® air filter onto the mass air sensor assembly as shown.

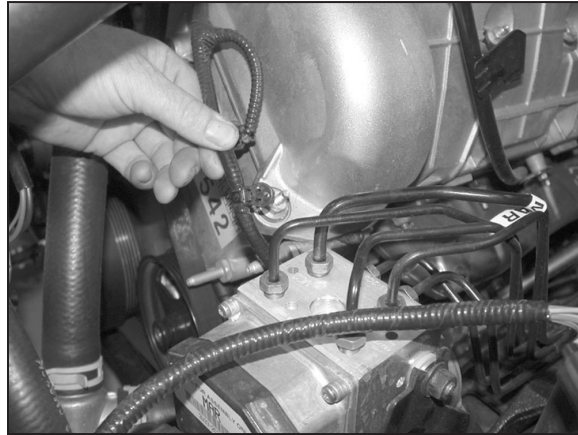

16. Pull up to release the wiring harness clip from valve cover mounting stud.

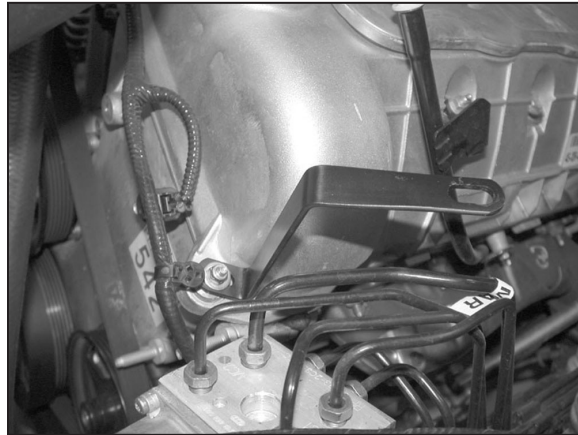

17. Install the tube-mounting bracket (010086) onto the valve cover-mounting stud exposed in step #16 and secure with the provided wire tie to secure the wire harness to the installed bracket.



18. Install the provided silicone hose (08623) onto the throttle body and secure with the hose clamp provided.

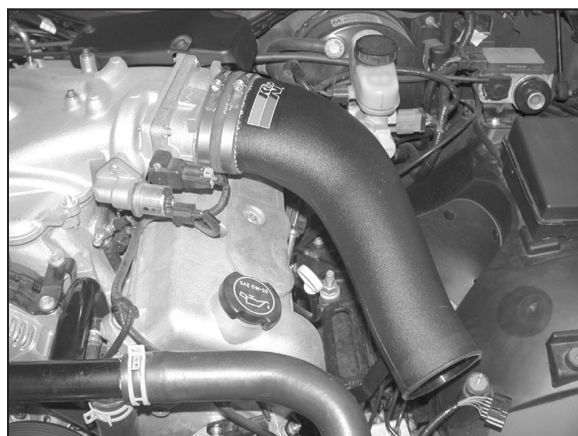

19. Install the K&N® intake tube into the silicone hose at the throttle body and secure with the provided hose clamp.

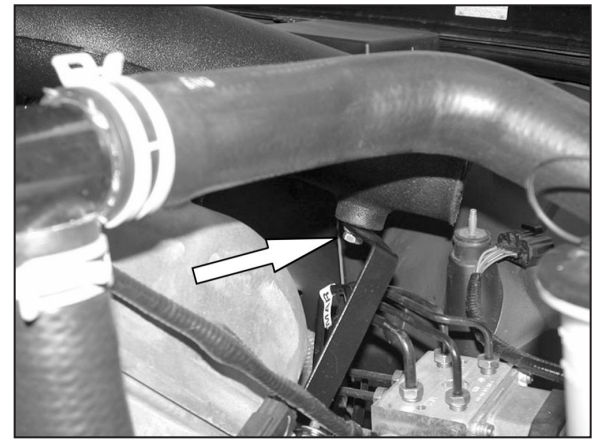

20. Using the provided 8mm bolt, secure the intake tube to the tube-mounting bracket installed in step #17.



21. Install the supplied silicone vent hose onto the crank case vent fitting in the valve cover and onto the K&N® intake tube as shown.



22. Install the mass air filter assembly onto the K&N® intake tube and secure with the provided hose clamp.

NOTE: Drycharger® air filter wrap; part # RF-1041DK is available to purchase separately. To learn more about Drycharger® filter wraps or look up color availability please visit <http://www.knfilters.com>®.



23. Reconnect the mass air sensor electrical connection as shown.



24. Reconnect the vehicle's negative battery cable. Double check to make sure everything is tight and properly positioned before starting the vehicle.

25. The C.A.R.B. exemption sticker, (attached), must be visible under the hood so that an emissions inspector can see it when the vehicle is required to be tested for emissions. California requires testing every two years, other states may vary.

26. It will be necessary for all K&N® high flow intake systems to be checked periodically for realignment, clearance and tightening of all connections. Failure to follow the above instructions or proper maintenance may void warranty.

ROAD TESTING:

1. Start the engine with the transmission in neutral or park, and the parking brake engaged. Listen for air leaks or odd noises. For air leaks secure hoses and connections. For odd noises, find cause and repair before proceeding. This kit will function identically to the factory system except for being louder and much more responsive.

2. Test drive the vehicle. Listen for odd noises or rattles and fix as necessary.

3. If road test is fine, you can now enjoy the added power and performance from your kit.

4. K&N Engineering, Inc., requires cleaning the intake system's air filter element every 100,000 miles. When used in dusty or off-road environments, our filters will require cleaning more often. We recommend that you visually inspect your filter once every 25,000 miles to determine if the screen is still visible. When the screen is no longer visible some place on the filter element, it is time to clean it. To clean and re-oil, purchase our filter Recharger® service kit, part number 99-5050 or 99-5000 and follow the easy instructions.

INTAKE SYSTEMS FOR VEHICLES LISTED ARE 50 STATE LEGAL. SEE KNFILTERS.COM FOR CARB STATUS ON EACH PART FOR A SPECIFIC VEHICLE.