



INTAKE SYSTEMS FOR VEHICLES LISTED ARE 50 STATE LEGAL. SEE KNFILTERS.COM FOR CARB STATUS ON EACH PART FOR A SPECIFIC VEHICLE.

INSTALLATION INSTRUCTIONS

57-2569
FORD
2006 F-150
V8-4.6L

NOTE: This kit was not designed to fit vehicles with a body lift.

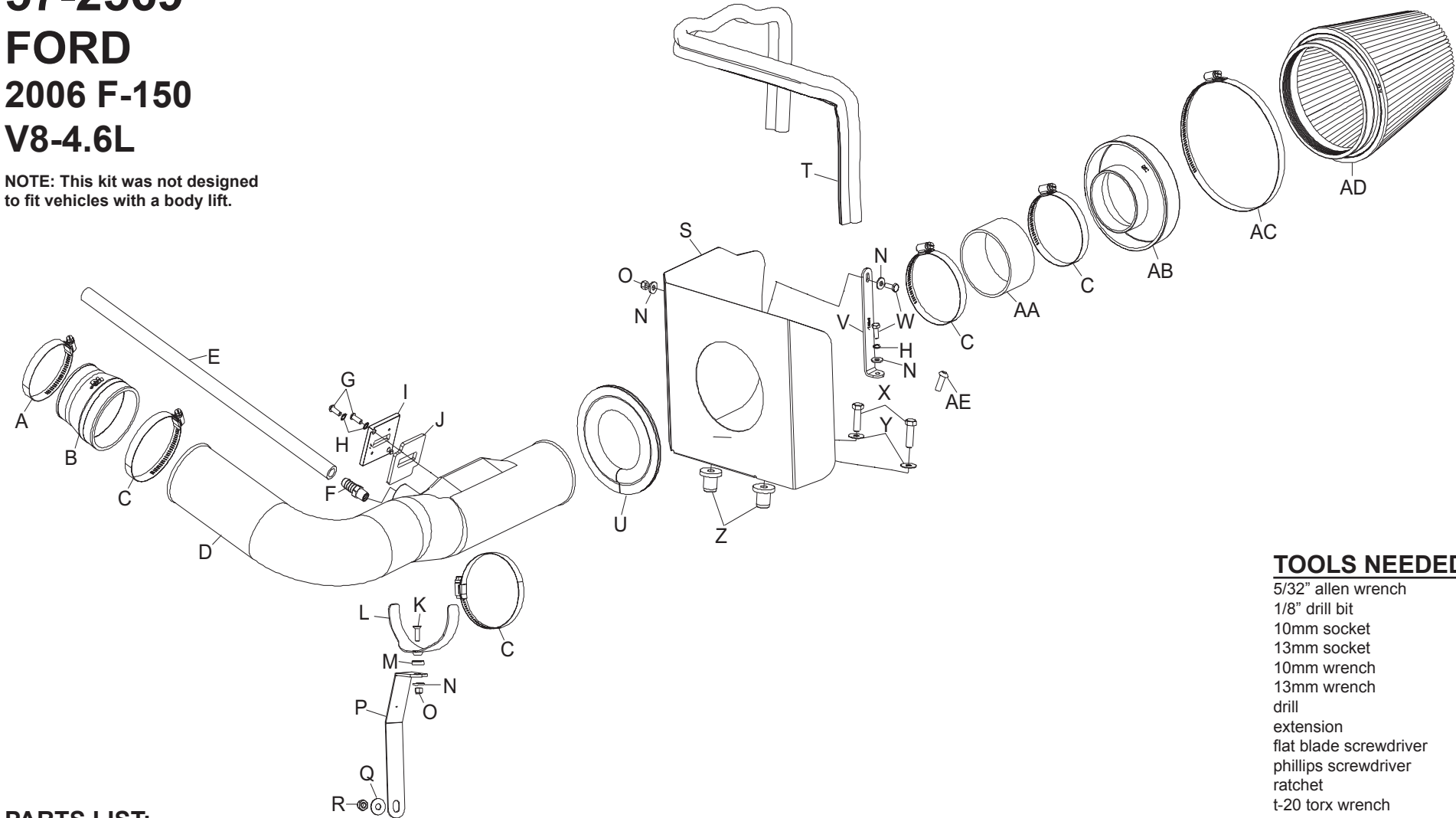

TOOLS NEEDED:

- 5/32" allen wrench
- 1/8" drill bit
- 10mm socket
- 13mm socket
- 10mm wrench
- 13mm wrench
- drill
- extension
- flat blade screwdriver
- phillips screwdriver
- ratchet
- t-20 torx wrench

PARTS LIST:

Description	Qty.	Part #	Description	Qty.	Part #	Description	Qty.	Part #
A Hose Clamp #48	1	08601	L Bracket; Saddle, S/S	1	078855	W Bolt; M6-1.00 x 16mm Hex Head.	2	07703
B Hose; 3.5"ID to 3"ID Tprd., Silicone	1	08724	M Washer; Conical, Nylon, Black	1	08180	X Bolt; 3/8"-16 x 1-1/4"L SS Hex Head	2	07779
C Hose Clamp #56	4	08620	N Washer; 1/4"ID X 5/8"OD - SAE	4	08275	Y Washer; 3/8" Flat SS	2	08134
D Intake Tube (GC)	1	087201	O Nut; 6mm Nylock, Hex Head	2	07553	Z Insert; 3/8-16 x 3/400 x 15/16L, Rubber	2	08163
E Hose; 1/2"ID x 19"L, Silicone	1	084075	P Bracket; Mild Stl. FB/PC	1	26631	AA Hose; 3.5"ID x 2"L, Silicone	1	08630
F Vent; Strt. 1/2" Hose, 1/4" NPT	1	080022	Q Washer; 5/16"ID x 5/8"OD, Flat	1	08276	AB Adapter; #380	1	21512-1
G Bolt; M6 x 1.00 x 16mm, Buttonhead, SS	2	07730	R Nut; 8mm Nylock	1	07542	AC Hose Clamp #104	1	08697
H Washer; 1/4" Lock, ZN	3	08198	S Heat Shield	1	074021	AD Air Filter	1	RF-1041
I Adapter; Nylon 6/6 GF	1	21515	T Edge Trim (55")	1	102480	AE Screw: #12 Sheet Metal 5/8" L	1	07788
J Gasket; 3/16 Poron	1	09069	U Edge Trim (17")	1	102469			
K Bolt; 6mm-1.00 x 20mm F/H/A, SS	1	08376	V Bracket; Small "L"	1	070026			

NOTE: FAILURE TO FOLLOW INSTALLATION INSTRUCTIONS AND NOT USING THE PROVIDED HARDWARE MAY DAMAGE THE INTAKE TUBE, THROTTLE BODY AND ENGINE.

TO START:

1. Turn off the ignition and disconnect the negative battery cable.

NOTE: Disconnecting the negative battery cable erases pre-programmed electronic memories. Write down all memory settings before disconnecting the negative battery cable. Some radios will require an anti-theft code to be entered after the battery is reconnected. The anti-theft code is typically supplied with your owner's manual. In the event your vehicles' anti-theft code cannot be recovered, contact an authorized dealership to obtain your vehicles anti-theft code.



2. Rotate the crank case vent hose locking ring and pull the crank case vent hose off of the valve cover.



3. Loosen the stock intake tube hose clamps, and remove the intake tube from vehicle.



4. Unhook the secondary mass air sensor electrical connection from the power steering reservoir bracket, then unlock the electrical connection locking tabs and separate the electrical connection



5. Pull firmly up on the air filter assembly to remove it from the mounting grommets.
NOTE: K&N Engineering, Inc., recommends that customers do not discard factory air intake.

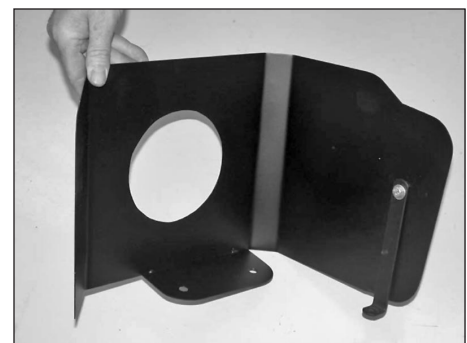

6. Install "L" bracket (070026) onto the heatshield with the hardware provided as shown.



7. Install the edge trim onto the heatshield as shown.
NOTE: Some trimming of the edge trim may be necessary.



8. Install the edge trim into the hole in the heat shield as shown.

NOTE: Some trimming of the edge trim may be necessary.



9. Install the provided nut inserts into the air box mounting holes as shown.

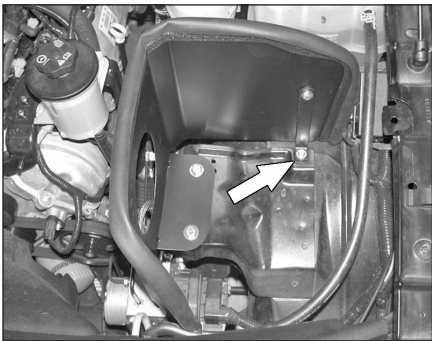

10. Install the heatshield as shown and secure with the provided hardware.

NOTE: Due to manufacture inconsistencies, some vehicles may not be equipped with threaded hole in the factory filter mounting plate. It will be necessary to drill a 1/8" hole in the air filter mounting plate and attach the heat shield bracket with the sheet metal screw provided.

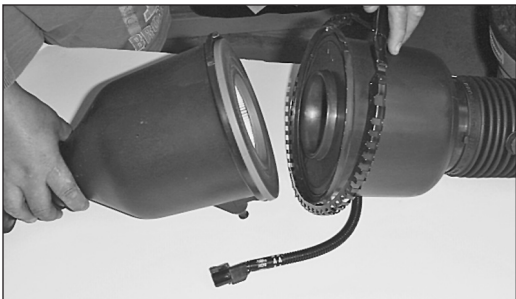

11. Open the air cleaner assembly and isolate the mass air sensor assembly.



12. Slide the rubber grommet back and disconnect the primary mass air sensor electrical connection, using a flat blade screwdriver.



13. Using a flat blade screwdriver, push in and release the four clips that retain the mass air sensor retaining plate.

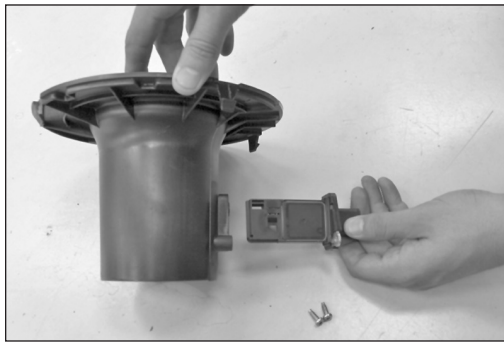

14. Remove the mass air sensor retaining screws and then remove the mass air sensors from it's housing as shown.

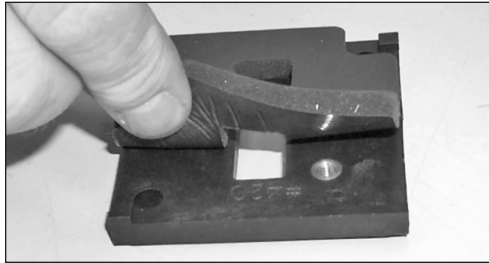

15. Remove the backing paper and install the mass air sensor adapter gasket as shown.

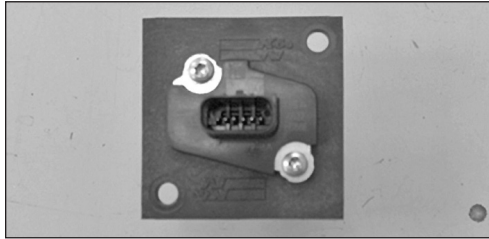

16. Install the mass air sensor into the adapter using the factory screws.

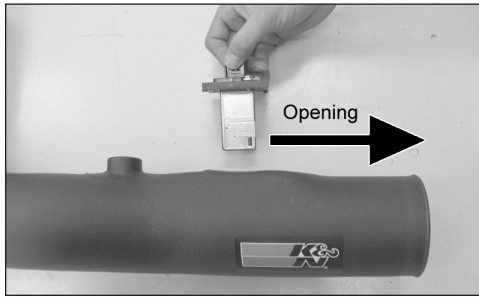

17. Install the mass air sensor assembly into the K&N® intake tube and secure with the provided hardware.

NOTE: The opening in the mass air sensor will point towards the filter end of the tube as shown.

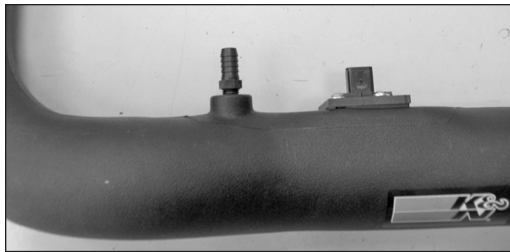

18. Install the provided 1/4" npt fitting into the K&N® intake tube as shown.

NOTE: Plastic NPT fittings are easy to cross thread. Install the vent fitting "hand" tight, then turn it two complete turns with a wrench.



19. Install silicone hose (08724) onto the throttle body with the provided hose clamp as shown.



20. Install the saddle clamp onto the tube mounting bracket as shown using the provided hardware.

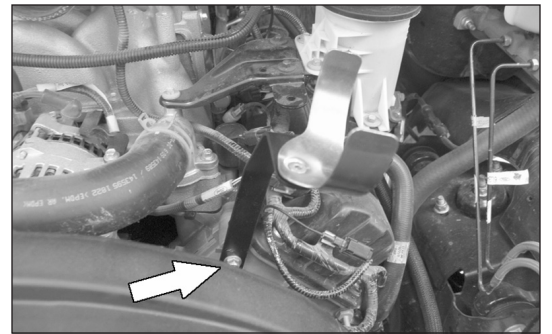

21. Install the tube mounting bracket assembly onto the 8mm stud protruding from the engine with the nut and washer provided.



22. Install the K&N® intake tube into the silicone hose at the throttle body and onto the tube mounting bracket assembly. Secure with the provided hose clamps.



23. Install the provided silicone vent hose onto the valve cover and onto the K&N® intake tube as shown.



24. Install the filter adapter into the K&N® air filter and secure with the provided hose clamp.

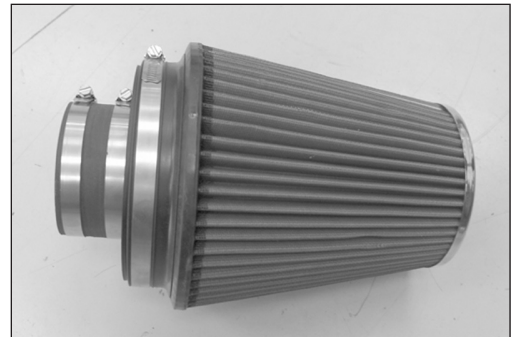

25. Install the silicone hose (08630) onto the filter assembly and secure with the provided hose clamp.



26. Install the filter assembly onto the K&N® intake tube and secure with the provided hose clamp.

NOTE: Drycharger® air filter wrap; part # RF-1041DK is available to purchase separately. To learn more about Drycharger® filter wraps or look up color availability please visit <http://www.knfilters.com>®.

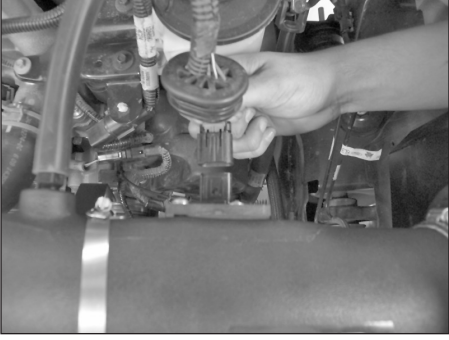

27. Reconnect the secondary mass air sensor electrical connection and then reconnect the mass air sensor primary electrical connection.



28. Reconnect the vehicle's negative battery cable. Double check to make sure everything is tight and properly positioned before starting the vehicle.

29. The C.A.R.B. exemption sticker, (attached), must be visible under the hood, so the emissions inspector can see it when the vehicle is required to be tested for emissions. California requires testing every two years, other states may vary.

30. It will be necessary for all K&N® high flow intake systems to be checked periodically for realignment, clearance and tightening of all connections. Failure to follow the above instructions or proper maintenance may void warranty.

ROAD TESTING:

1. Start the engine with the transmission in neutral or park, and the parking brake engaged. Listen for air leaks or odd noises. For air leaks secure hoses and connections. For odd noises, find cause and repair before proceeding. This kit will function identically to the factory system except for being louder and much more responsive.

2. Test drive the vehicle. Listen for odd noises or rattles and fix as necessary.

3. If road test is fine, you can now enjoy the added power and performance from your kit.

4. K&N Engineering, Inc., suggests checking the air filter element periodically for excessive dirt build-up. When the element becomes covered in dirt (or once a year), service it according to the instructions on the Recharger® service kit, part number 99-5050 or 99-5000.

INTAKE SYSTEMS FOR VEHICLES LISTED ARE 50 STATE LEGAL. SEE KNFILTERS.COM FOR CARB STATUS ON EACH PART FOR A SPECIFIC VEHICLE.