



LEGAL IN CALIFORNIA ONLY FOR RACING VEHICLES WHICH MAY NEVER BE USED, REGISTERED OR LICENSED FOR USE UPON A HIGHWAY. See knfilters.com for CARB status on each part for a specific vehicle

# INSTALLATION INSTRUCTIONS

**69-8618TS**  
**TOYOTA/LEXUS**  
**2012-17 Camry**  
**2013-17 Avalon**  
**2013-17 ES350**  
**V6-3.5L**

**TOOLS NEEDED:**

- flat blade screw driver
- Phillips screw driver
- ratchet, extension
- 10mm socket
- 8mm socket
- 9/16" socket
- 10mm wrench
- 3mm wrench.

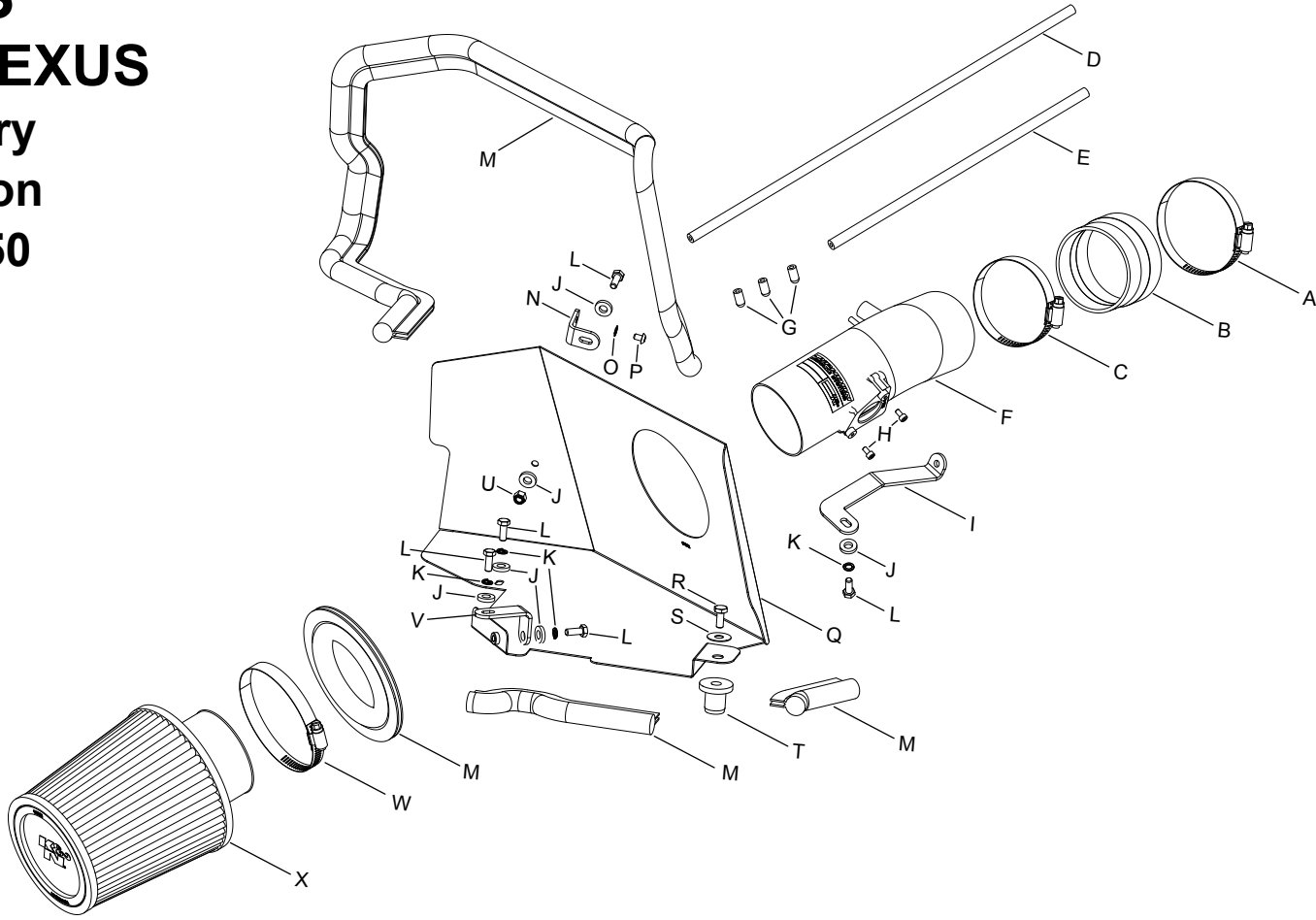

**PARTS LIST:**

Description	Qty.	Part #	Description	Qty.	Part #	Description	Qty.	Part #
A HOSE CLAMP # 48	1	08601	I BRACKET; "L", 69-8611, STL	1	06485	Q HEAT SHIELD	1	07392
B HOSE; 3-1/8" TO 3"ID X 2"L	1	084031	J WASHER; 1/4"ID X 5/8" OD -SAE	6	08275	R BOLT; 3/8"-16 X 1-1/4"L SS HEX	1	07779
C HOSE CLAMP # 44 STAINLESS	1	08560	K WASHER; M6 SPLIT LOCK ZINC	4	1-3025	S WASHER; 3/8" FLAT WASHER	1	08134
D HOSE; 4MM ID X 18"L	1	08153	L BOLT; 6MM-1.00 X 16MM, SS	5	07812	T INSERT; 3/8-16 X 3/4 X 15/16L	1	08163
E RUBBER HOSE; 4MM ID X 12"L	1	08147	M EDGE TRIM; (70")	1	102454	U NUT; 6MM NYLOCK, HEXHEAD	1	07512
F INTAKE TUBE	1	27528TS	N BRACKET; 69-2521, "L", SML	1	070066A	V BRACKET; 57-3021, L-BEND	1	070812A
G CAP; RUBBER 5/16"OD X 5/32"	3	08282	O WASHER; 5MM INTERNAL	1	07724	W HOSE CLAMP # 52	1	08610
H BOLT; M4-.7 X 8MM	2	07733	P BOLT; M5 X .8 X 8MM, SS	1	07740	X AIR FILTER	1	RU-4990

**If you need any assistance please call 1-800-858-3333 to speak with a representative in our Customer Service Center before returning the product.**

**NOTE: FAILURE TO FOLLOW INSTALLATION INSTRUCTIONS AND NOT USING THE PROVIDED HARDWARE MAY DAMAGE THE INTAKE TUBE, THROTTLE BODY AND ENGINE.**

**TO START:**

1. Turn off the ignition and disconnect the negative battery cable.  
**NOTE: Disconnecting the negative battery cable erases pre-programmed electronic memories. Write down all memory settings before disconnecting the negative battery cable. Some radios will require an anti-theft code to be entered after the battery is reconnected. The anti-theft code is typically supplied with your owner's manual. In the event your vehicles' anti-theft code cannot be recovered, contact an authorized dealership to obtain your vehicles anti-theft code.**



2. Lift up the engine cover and remove it from the vehicle.



3. Disconnect the vacuum line shown from the intake plenum.



4. Disconnect the crank case vent hose from the intake tube.



5. Loosen the hose clamp securing the intake tube to the throttle body.



6. Disconnect the mass air sensor electrical connection and then unhook the wiring harness from the air box.

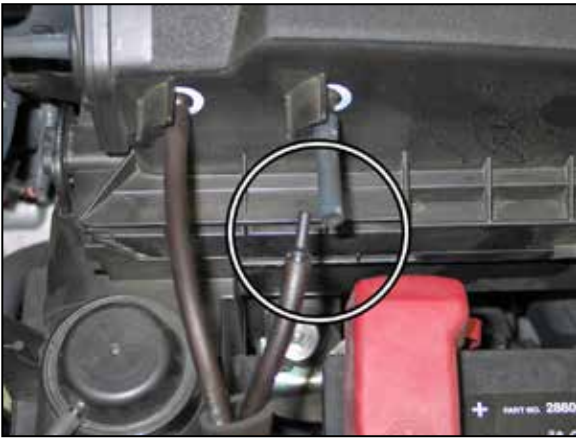

7. Disconnect the vacuum line from the union fitting shown leaving the union installed into the vacuum line attached to the vehicle.



8. Disconnect the vacuum line at the TEE fitting shown.

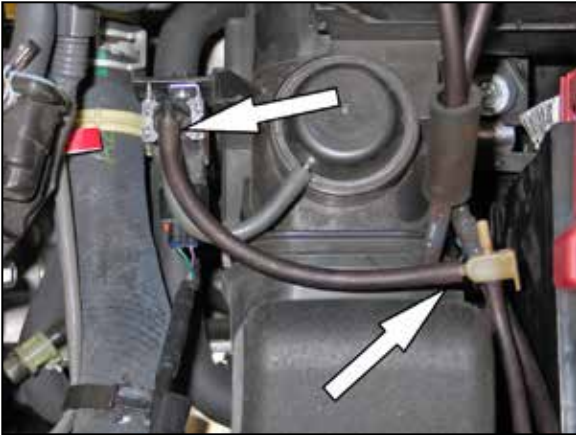

9. Remove the vacuum hose shown from the TEE fitting and vacuum switching valve.

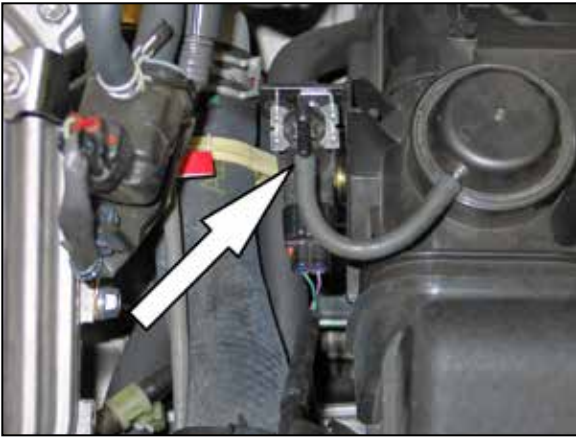

10. Disconnect the lower vacuum hose from the vacuum switching valve.



11. Remove the 7 clips securing the upper valance and then remove the upper valance from the vehicle.

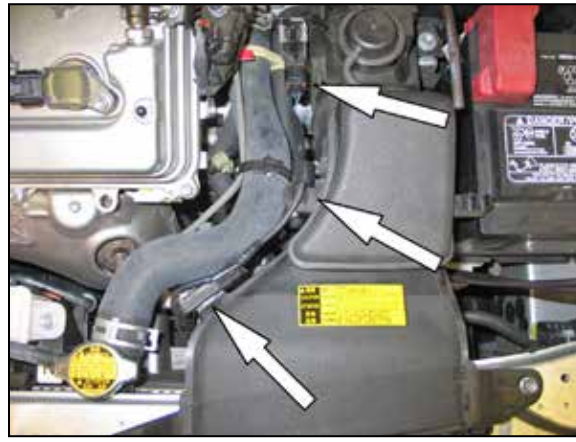

12. Disconnect the vacuum switch electrical connection and then unhook the harness from the fresh air duct.



13. Remove the two bolts securing the fresh air duct and then remove the fresh air duct from the vehicle.



14. Remove the two bolts shown securing the air box.



15. Remove the air box from the vehicle.  
**NOTE: K&N Engineering, Inc., recommends that customers do not discard factory air intake.**



16. Remove the air box mounting grommet shown.

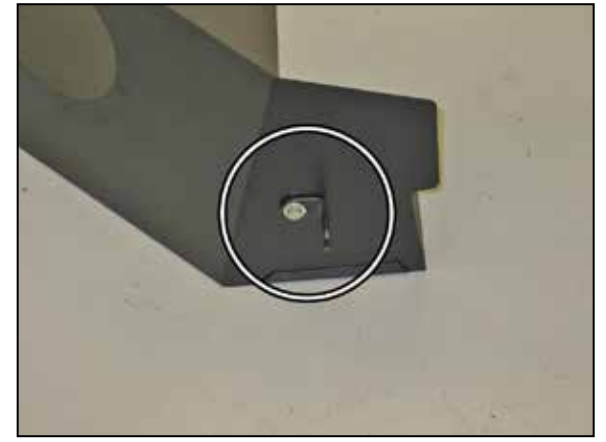

17. Install the heat shield mounting bracket (070066) onto the heat shield using the provided hardware.

**NOTE: The slotted end of the bracket attaches to the heat shield.**

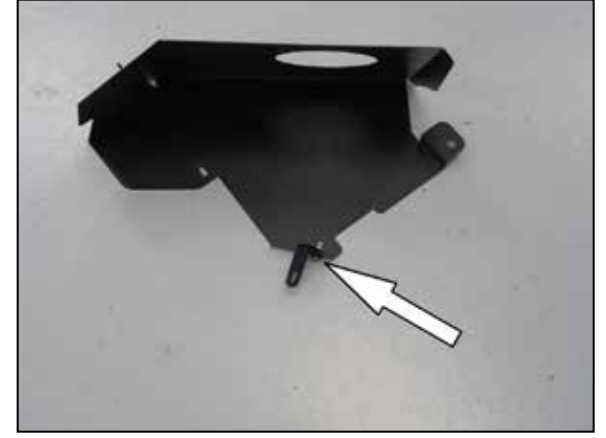

18. Install the heat shield mounting bracket (070812) onto the heat shield using the provided hardware.

**NOTE: Do not completely tighten at this time.**

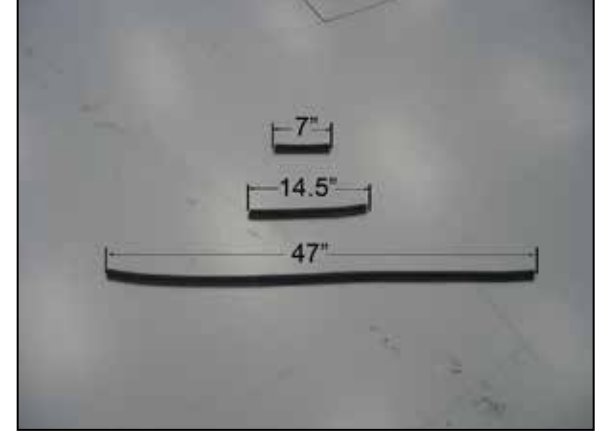

19. Cut the provided edge trim into three sections, the long section is 47" long, the medium section is 14-1/2" long, the short section is 7" long.

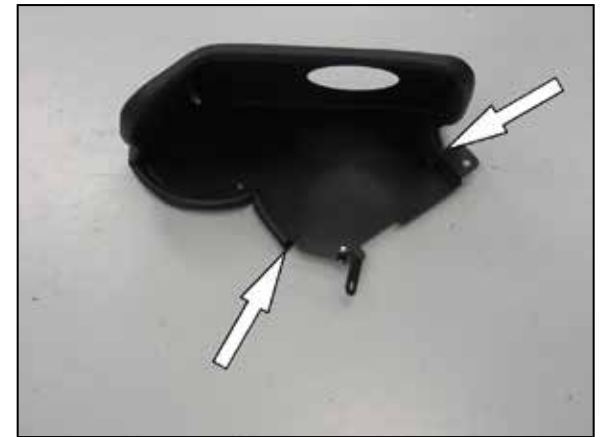

20. Install the 47" long section of edge trim onto the heat shield as shown.



21. Install the 14.5" length edge trim into the hole of the heat shield as shown.

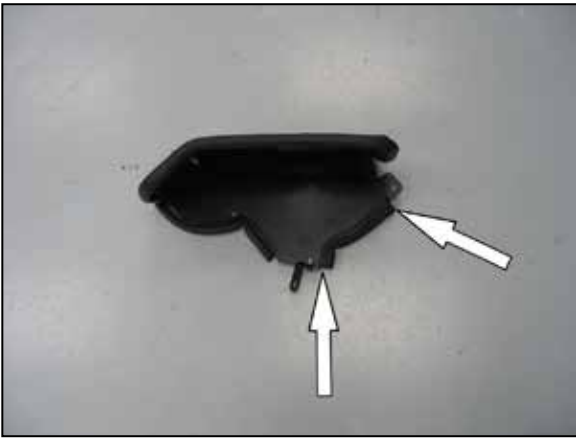

22. Install the 7" section of edge trim onto the heat shield as shown.



23. Remove the vacuum switching valve from the air box as shown.



24. Secure the vacuum switching valve to the "L" bracket installed onto the heat shield as shown and then install the provided vacuum caps.



25. Install the provided inserted nut into the heat shield mounting bracket location.



26. Set the heat shield into position and secure with the provided hardware.



27. Remove the front lower throttle body mounting bolt shown.  
**NOTE: This bolt will be reused in the next step.**



28. Install the tube mounting bracket (06485) onto the throttle body securing with the factory bolt removed in the previous step.  
**NOTE: Do not completely tighten at this time.**



29. Install the silicone hose #084031 onto the throttle body and secure with the provided hose clamp.



30. Remove the two screws securing the mass air sensor and then remove the mass air sensor from the factory air box.



31. Install the mass air sensor into the K&N® intake tube and secure with the provided hardware.



32. Install the K&N® intake tube into the silicone hose at the throttle body and align with the tube mounting bracket. Align the tube and bracket for proper fit and then secure with the provided hardware and hose clamp.



33. Connect the crank case vent hose to the K&N® intake tube and secure with the factory clamp.



34. Reinstall the fresh air intake scoop and secure with the factory hardware.



35. Install the provided vacuum plug onto the vacuum TEE.



36. Install the provided longer vacuum hose to the vacuum TEE and install the open end onto the intake plenum.



37. Connect the shorter provided vacuum line to the open factory union fitting and then connect the open end to the K&N® intake tube.

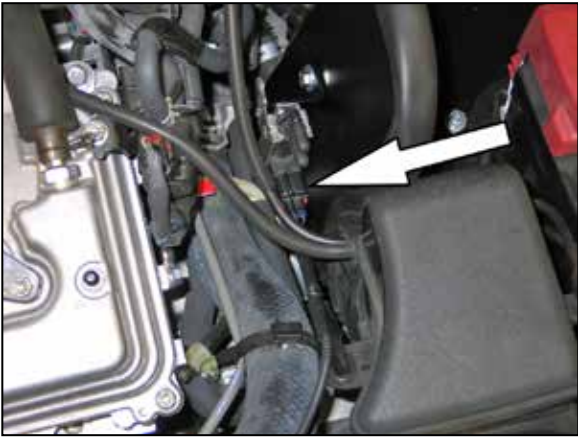

38. Reconnect the vacuum switching valve electrical connection and secure the wiring harness to the fresh air intake scoop.



39. Reinstall the valence and secure with the factory retaining clips.



40. Reconnect the mass air sensor electrical connection.



41. Install the K&N® air filter and secure with the provided hose clamp.

**NOTE: Drycharger® air filter wrap; part # RX-4990DK is available to purchase separately. To learn more about Drycharger® filter wraps or look up color availability please visit <http://www.knfilters.com>®.**



42. Install the engine cover.



43. Reconnect the vehicle's negative battery cable. Double check to make sure everything is tight and properly positioned before starting the vehicle.

44. It will be necessary for all K&N® high flow intake systems to be checked periodically for realignment, clearance and tightening of all connections. Failure to follow the above instructions or proper maintenance may void warranty.

#### ROAD TESTING:

1. Start the engine with the transmission in neutral or park, and the parking brake engaged. Listen for air leaks or odd noises. For air leaks secure hoses and connections. For odd noises, find cause and repair before proceeding. This kit will function identically to the factory system except for being louder and much more responsive.

2. Test drive the vehicle. Listen for odd noises or rattles and fix as necessary.

3. If road test is fine, you can now enjoy the added power and performance from your kit.

4. K&N Engineering, Inc., requires cleaning the intake system's air filter element every 100,000 miles. When used in dusty or off-road environments, our filters will require cleaning more often. We recommend that you visually inspect your filter once every 25,000 miles to determine if the screen is still visible. When the screen is no longer visible some place on the filter element, it is time to clean it. To clean and re-oil, purchase our filter Recharger® service kit, part number 99-5050 or 99-5000 and follow the easy instructions.

**LEGAL IN CALIFORNIA ONLY FOR RACING VEHICLES WHICH MAY NEVER BE USED, REGISTERED OR LICENSED FOR USE UPON A HIGHWAY.**

See [knfilters.com](http://knfilters.com) for CARB status on each part for a specific vehicle